



Article Summary

Version 1

	Article Code	C-0326-KT-7427	Material Description	Product Group	TOP	
	Article Name	NHL 26 COLOUR BLOCK RUGBY		Product Sub-Category	T-SHIRT - LS	
	Created On	10-03-2025 5:13:00 PM		Season	Q3 2026	
	Last Modified	12-23-2025 11:39:00 AM		Life Cycle Stage		

Gender Classification	Collaboration	Sub Class D	LS POLO	Fabrication	KNIT TOP
Supplier	UN-AVAILABLE CO. LTD	Release Date	23 Oct 2026	Ex-Factory	17 Jul 2026

COLORS



	ANAHEIM DUCKS ORANGE (ADO) RED ORANGE. 17-1464 TCX		NEW JERSEY DEVILS RED (NDR) RACING RED. 19-1763 TCX
	BUFFALO SABRES BLUE (BFB) TWILIGHT BLUE. 19-3938		NASHVILLE PREDATORS NAVY (NPN) PEACOAT 19-3920 TCX
	COLORADO AVALANCHE BURGUNDY (CAG) CORDOVAN. 19-1726 TCX		NEW YORK ISLANDERS BLUE (NYI) SURF THE WEB. 19-3952
	CALGARY FLAMES RED (CFR) RACING RED - 19-1763 TCX		BLUE - NEW YORK RANGERS (NYR) 19-3952 TCX
	CAROLINA HURRICANES RED (CHR) RACING RED. 19-1763 TCX		OTTAWA SENATORS BLACK (OSB) OVO Black Standard
	COLUMBUS BLUE JACKETS BLUE (COB) PEACOAT 19-3920 TCX		BLACK - PITTSBURGH PENGUINS BLACK (PPB) BLACK - PITTSBURGH
	DALLAS STARS GREEN (DSG) VERDANT GREEN. 19-6026		MONTREAL CANADIENS RED (RMC) LIPSTICK RED. 19-1764
	DETROIT RED WINGS RED (DTR) RACING RED. 19-1763 TCX		SAN JOSE SHARKS TEAL (SJS) OCEAN DEPTHS. 19-4535
	EDMONTON OILERS NAVY (EON) PEACOAT - 19-3920 TCX		SEATTLE KRAKEN NAVY (SKN) SKY CAPTAIN. 19-3922 TCX
	FLORIDA PANTHERS RED (FPR) RACING RED. 19-1763 TCX		ST. LOUIS BLUES BLUE (SXB) SURF THE WEB, 19-3952 TCX
	LAS VEGAS GOLDEN KNIGHTS - GREY (LVG) STRATIFIED SEA. 19-4112		TORONTO MAPLE LEAFS - BLUE (TOB) TWILIGHT BLUE. 19-3938
	MINNESOTA WILD GREEN (MWG) HUNTER GREEN. 19-5511		TAMPA BAY LIGHTENING BLUE (TXB) TWILIGHT BLUE. 19-3938

SIZES

000, 001, 002, 003, 004, 005, 006, 007

Article Summary

Version 1



Article Code	C-0326-KT-7427	Product Group	TOP
Article Name	NHL 26 COLOUR BLOCK RUGBY	Product Sub-Category	T-SHIRT - LS
Created On	10-03-2025 5:13:00 PM	Season	Q3 2026
Last Modified	12-23-2025 11:39:00 AM	Life Cycle Stage	
Material Description	HEAVY JERSEY_100% COTTON_SOLID_320_S0004 (FB-K1597)		

Gender Classification	Collaboration	Sub Class D	LS POLO	Fabrication	KNIT TOP
Supplier	UN-AVAILABLE CO. LTD	Release Date	23 Oct 2026	Ex-Factory	17 Jul 2026

COLORS





	VANCOUVER CANUCKS BLUE (VCB) TWILIGHT BLUE. 19-3938
	WINNIPEG JETS NAVY (WPN) PEACOAT 19-3920 TCX
	WASHINGTON CAPITALS BLUE (WXB) PEACOAT 19-3920 TCX

SIZES

000, 001, 002, 003, 004, 005, 006, 007

Bill of Materials - Production | #1

Version 1

	Article Code	C-0326-KT-7427		Material Description	HEAVY JERSEY_100% COTTON_SOLID_320_S0004 (FB-K1597)		Product Group	TOP		
	Article Name	NHL 26 COLOUR BLOCK RUGBY			Product Sub-Category	T-SHIRT - LS				
	Created On	10-03-2025 5:13:00 PM			Season	Q3 2026				
	Last Modified	12-23-2025 11:39:00 AM			Life Cycle Stage					

Part	Material	Placement	Consumption	UOM.	Comments	Supplier	Supplier Ref.	ADO ANAHEIM DUCKS ORANGE	BFB BUFFALO SABRES BLUE	CAG COLORADO AVALANCHE BURGUNDY	CFR CALGARY FLAMES RED	CHR CAROLINA HURRICANES RED	COB COLUMBUS BLUE JACKETS BLUE	DSG DALLAS STARS GREEN
------	----------	-----------	-------------	------	----------	----------	---------------	--------------------------	-------------------------	---------------------------------	------------------------	-----------------------------	--------------------------------	------------------------

Fabric

	HEAVY JERSEY_100% COTTON_SOLID_320_S0004 (FB-K1597) - Ver.#1		0.000 0	Meter				None	None	None	None	None	None	None
	1X1 RIB COTTON /LYCRA (FB-K1066) - Ver.#1 WEIGHT TBD	CUFF	0.000 0	Meter				None	None	None	None	None	None	None
	COTTON TWILL (FB-W167) - Ver.#1		0.000 0	Meter	MATCH TO REFERENCE (GOLFWANG)			None	None	None	None	None	None	None

Trims

	TEAR-AWAY COO TAB: OVOF21_217_T (LT138) - Ver.#1 COUNTRY OF ORIGIN TAB		0.000 0	Each		Reca Mainetti Asia Ltd	OVOF21_217_T	None	None	None	None	None	None	None
	5mm GROSGRAIN RIBBON LOOP (TR-TV140) - Ver.#1 FOR HANGTAG ATTACHMENT		0.000 0	Each		Vendor Sourced		None	None	None	None	None	None	None
	OVO 2023 Booklet Hangtag (TR-HG142) - Ver.#1 Article code: HTOVO14 1A		0.000 0	Each		Reca Mainetti Asia Ltd	HTOVO141A	None	None	None	None	None	None	None

Bill of Materials - Production | #1



Version 1



Article Code	C-0326-KT-7427	Material Description	HEAVY JERSEY_100% COTTON_SOLID_320_S0004 (FB-K1597)	Product Group	TOP
Article Name	NHL 26 COLOUR BLOCK RUGBY		Product Sub-Category	T-SHIRT - LS	
Created On	10-03-2025 5:13:00 PM	Life Cycle Stage		Season	Q3 2026
Last Modified	12-23-2025 11:39:00 AM				

Part	Material	Placement	Consumption	UOM.	Comments	Supplier	Supplier Ref.	ADO ANAHEIM DUCKS ORANGE	BFB BUFFALO SABRES BLUE	CAG COLORADO AVALANCHE BURGUNDY	CFR CALGARY FLAMES RED	CHR CAROLINA HURRICANES RED	COB COLUMBUS BLUE JACKETS BLUE	DSG DALLAS STARS GREEN
	CC LABEL - APPAREL (LT110) - Ver.#1 White Satin ground, Black text COO, Content, and Care Instructions may vary by style.		0.000 0	Each		Vendor Sourced		None	None	None	None	None	None	None
	POLY BAG - GENERIC (PK101) - Ver.#1 Clear Plastic, with suffocation warning on back, UPC sticker placement on bottom right corner of bag.		0.000 0	Each		Vendor Sourced		None	None	None	None	None	None	None
	UPC STICKER- 1" X 2.5" (TR-ST114) - Ver.#1 PLEASE PRINT WITH THERMAL PRINTER		0.000 0	Each		Vendor Sourced		None	None	None	None	None	None	None
SEE PLACEMENT FOR DETAILS	OVO x NHL Main Label & Size Tab (TR-LT285) - Ver.#1 CADICA: OVOW24_042_T		1.000 0	Each	CADICA	CADICASI A HONG KONG LIMITED		None	None	None	None	None	None	None
	OVO x NHL SIZE TAB (TR-LT289) - Ver.#1 CADICA: OVOW24_042_T		0.000 0	Each		CADICASI A HONG KONG LIMITED		None	None	None	None	None	None	None

Bill of Materials - Production | #1

	Article Code	C-0326-KT-7427	Material Description	HEAVY JERSEY_100% COTTON_SOLID_320_S0004 (FB-K1597)	Product Group	TOP	
	Article Name	NHL 26 COLOUR BLOCK RUGBY		Product Sub-Category	T-SHIRT - LS		
	Created On	10-03-2025 5:13:00 PM		Season	Q3 2026		
	Last Modified	12-23-2025 11:39:00 AM		Life Cycle Stage			

Part	Material	Placement	Consumption	UOM.	Comments	Supplier	Supplier Ref.	ADO ANAHEIM DUCKS ORANGE	BFB BUFFALO SABRES BLUE	CAG COLORADO AVALANCHE BURGUNDY	CFR CALGARY FLAMES RED	CHR CAROLINA HURRICANES RED	COB COLUMBUS BLUE JACKETS BLUE	DSG DALLAS STARS GREEN
SEE PLACEMENT FOR DETAILS	NHL HOLOGRAPHIC HANGTAG (TR-HG164) - Ver.#1		1.000 0	Each				None	None	None	None	None	None	None
	OVO x NHL Hangtag (TR-HG149) - Ver.#1 CADICA OVOW24_044_T		1.000 0	Each		CADICASI A HONG KONG LIMITED		None	None	None	None	None	None	None
	RUBBER BUTTONS (TR-BB141) - Ver.#1		0.000 0	Each	3 +1 SPARE, 24L WHITE- PLS SUBMIT FOR QLTY /SIZE APPROVAL	Vendor Sourced		None	None	None	None	None	None	None
	100% COTTON HERRINGBONE TAPE (TV116) - Ver.#1 100% Cotton Herringbone Twill Taping inside CF placket. Follow specs for width.	BACK NECK TAPE, SIDE SLITS	0.000 0	Meter	white on all colourways	Vendor Sourced		None	None	None	None	None	None	None
	EMBOIDERED EYELET (TR-DE126) - Ver.#1	underarm 2 at back and 2 at front	4.000 0	Each	dtm emb	Vendor Sourced		None	None	None	None	None	None	None
Graphics														
	TBD - SEE ARTWORK FILE (HT-102) - Ver.#1		0.000 0	Each				None	None	None	None	None	None	None

Bill of Materials - Production | #1

Version 1



Article Code	C-0326-KT-7427	Material Description	HEAVY JERSEY_100% COTTON_SOLID_320_S0004 (FB-K1597)	Product Group	TOP
Article Name	NHL 26 COLOUR BLOCK RUGBY		Product Sub-Category	T-SHIRT - LS	
Created On	10-03-2025 5:13:00 PM	Season	Q3 2026		
Last Modified	12-23-2025 11:39:00 AM	Life Cycle Stage			

Part	Material	Placement	Consumption	UOM.	Comments	Supplier	Supplier Ref.	DTR DETROIT RED WINGS RED	EON EDMONTON OILERS NAVY	FPR FLORIDA PANTHERS RED	LVG LAS VEGAS GOLDEN KNIGHTS - GREY	MWG MINNESOTA WILD GREEN	NDR NEW JERSEY DEVILS RED	NPN NASHVILLE PREDATORS NAVY
------	----------	-----------	-------------	------	----------	----------	---------------	---------------------------------	--------------------------------	--------------------------------	----------------------------------------------	--------------------------------	---------------------------------	------------------------------------

Fabric

	HEAVY JERSEY_100% COTTON_SOLID_320_S0004 (FB-K1597) - Ver.#1		0.000 0	Meter				None	None	None	None	None	None	None
	1X1 RIB COTTON /LYCRA (FB-K1066) - Ver.#1 WEIGHT TBD	CUFF	0.000 0	Meter				None	None	None	None	None	None	None
	COTTON TWILL (FB-W167) - Ver.#1		0.000 0	Meter	MATCH TO REFERENCE (GOLFWANG)			None	None	None	None	None	None	None

Trims

	TEAR-AWAY COO TAB: OVOF21_217_T (LT138) - Ver.#1 COUNTRY OF ORIGIN TAB		0.000 0	Each		Reca Mainetti Asia Ltd	OVOF21_217_T	None	None	None	None	None	None	None
	5mm GROSGRAIN RIBBON LOOP (TR-TV140) - Ver.#1 FOR HANGTAG ATTACHMENT		0.000 0	Each		Vendor Sourced		None	None	None	None	None	None	None
	OVO 2023 Booklet Hangtag (TR-HG142) - Ver.#1 Article code: HTOVO14 1A		0.000 0	Each		Reca Mainetti Asia Ltd	HTOVO141A	None	None	None	None	None	None	None

Bill of Materials - Production | #1

Version 1



Article Code	C-0326-KT-7427	Material Description	HEAVY JERSEY_100% COTTON_SOLID_320_S0004 (FB-K1597)	Product Group	TOP
Article Name	NHL 26 COLOUR BLOCK RUGBY			Product Sub-Category	T-SHIRT - LS
Created On	10-03-2025 5:13:00 PM	Season	Q3 2026	Life Cycle Stage	
Last Modified	12-23-2025 11:39:00 AM				

Part	Material	Placement	Consumption	UOM.	Comments	Supplier	Supplier Ref.	DTR DETROIT RED WINGS RED	EON EDMONTON OILERS NAVY	FPR FLORIDA PANTHERS RED	LVG LAS VEGAS GOLDEN KNIGHTS - GREY	MWG MINNESOTA WILD GREEN	NDR NEW JERSEY DEVILS RED	NPN NASHVILLE PREDATORS NAVY
	CC LABEL - APPAREL (LT110) - Ver.#1 White Satin ground, Black text COO, Content, and Care Instructions may vary by style.		0.000 0	Each		Vendor Sourced		None	None	None	None	None	None	None
	POLY BAG - GENERIC (PK101) - Ver.#1 Clear Plastic, with suffocation warning on back, UPC sticker placement on bottom right corner of bag.		0.000 0	Each		Vendor Sourced		None	None	None	None	None	None	None
	UPC STICKER- 1" X 2.5" (TR-ST114) - Ver.#1 PLEASE PRINT WITH THERMAL PRINTER		0.000 0	Each		Vendor Sourced		None	None	None	None	None	None	None
SEE PLACEMENT FOR DETAILS	OVO x NHL Main Label & Size Tab (TR-LT285) - Ver.#1 CADICA: OVOW24_042_T		1.000 0	Each	CADICA	CADICASI A HONG KONG LIMITED		None	None	None	None	None	None	None
	OVO x NHL SIZE TAB (TR-LT289) - Ver.#1 CADICA: OVOW24_042_T		0.000 0	Each		CADICASI A HONG KONG LIMITED		None	None	None	None	None	None	None

Bill of Materials - Production | #1

Version 1



Article Code	C-0326-KT-7427	Material Description	HEAVY JERSEY_100% COTTON_SOLID_320_S0004 (FB-K1597)	Product Group	TOP
Article Name	NHL 26 COLOUR BLOCK RUGBY			Product Sub-Category	T-SHIRT - LS
Created On	10-03-2025 5:13:00 PM	Life Cycle Stage		Season	Q3 2026
Last Modified	12-23-2025 11:39:00 AM				

Part	Material	Placement	Consumption	UOM.	Comments	Supplier	Supplier Ref.	DTR DETROIT RED WINGS RED	EON EDMONTON OILERS NAVY	FPR FLORIDA PANTHERS RED	LVG LAS VEGAS GOLDEN KNIGHTS - GREY	MWG MINNESOTA WILD GREEN	NDR NEW JERSEY DEVILS RED	NPN NASHVILLE PREDATORS NAVY
SEE PLACEMENT FOR DETAILS	NHL HOLOGRAPHIC HANGTAG (TR-HG164) - Ver.#1		1.000 0	Each				None	None	None	None	None	None	None
	OVO x NHL Hangtag (TR-HG149) - Ver.#1 CADICA OVOW24_044_ T		1.000 0	Each		CADICASI A HONG KONG LIMITED		None	None	None	None	None	None	None
	RUBBER BUTTONS (TR-BB141) - Ver.#1		0.000 0	Each	3 +1 SPARE, 24L WHITE- PLS SUBMIT FOR QLTY /SIZE APPROVAL	Vendor Sourced		None	None	None	None	None	None	None
	100% COTTON HERRINGBONE TAPE (TV116) - Ver.#1 100% Cotton Herringbone Twill Taping inside CF placket. Follow specs for width.	BACK NECK TAPE, SIDE SLITS	0.000 0	Meter	white on all colourways	Vendor Sourced		None	None	None	None	None	None	None
	EMBOIDERED EYELET (TR-DE126) - Ver.#1	underarm 2 at back and 2 at front	4.000 0	Each	dtm emb	Vendor Sourced		None	None	None	None	None	None	None
Graphics														
	TBD - SEE ARTWORK FILE (HT-102) - Ver.#1		0.000 0	Each				None	None	None	None	None	None	None

Bill of Materials - Production | #1

Version 1



Article Code	C-0326-KT-7427	Material Description	HEAVY JERSEY_100% COTTON_SOLID_320_S0004 (FB-K1597)	Product Group	TOP
Article Name	NHL 26 COLOUR BLOCK RUGBY		Product Sub-Category	T-SHIRT - LS	
Created On	10-03-2025 5:13:00 PM		Season	Q3 2026	
Last Modified	12-23-2025 11:39:00 AM		Life Cycle Stage		

Part	Material	Placement	Consumption	UOM.	Comments	Supplier	Supplier Ref.	NYI NEW YORK ISLANDERS BLUE	NYR BLUE - NEW YORK RANGERS	OSB OTTAWA SENATORS BLACK	PPB BLACK - PITTSBURGH PENGUINS BLACK	RMC MONTREAL CANADIENS RED	SJS SAN JOSE SHARKS TEAL	SKN SEATTLE KRAKEN NAVY
------	----------	-----------	-------------	------	----------	----------	---------------	-----------------------------------	-----------------------------------	---------------------------------	------------------------------------------------	----------------------------------	--------------------------------	-------------------------------

Fabric

	HEAVY JERSEY_100% COTTON_SOLID_320_S0004 (FB-K1597) - Ver.#1		0.000 0	Meter				None	None	None	None	None	None	None
	1X1 RIB COTTON /LYCRA (FB-K1066) - Ver.#1 WEIGHT TBD	CUFF	0.000 0	Meter				None	None	None	None	None	None	None
	COTTON TWILL (FB-W167) - Ver.#1		0.000 0	Meter	MATCH TO REFERENCE (GOLFWANG)			None	None	None	None	None	None	None

Trims

	TEAR-AWAY COO TAB: OVOF21_217_T (LT138) - Ver.#1 COUNTRY OF ORIGIN TAB		0.000 0	Each		Reca Mainetti Asia Ltd	OVOF21_217_T	None	None	None	None	None	None	None
	5mm GROSGRAIN RIBBON LOOP (TR-TV140) - Ver.#1 FOR HANGTAG ATTACHMENT		0.000 0	Each		Vendor Sourced		None	None	None	None	None	None	None
	OVO 2023 Booklet Hangtag (TR-HG142) - Ver.#1 Article code: HTOVO14 1A		0.000 0	Each		Reca Mainetti Asia Ltd	HTOVO14 1A	None	None	None	None	None	None	None

Bill of Materials - Production | #1

Version 1





Article Code	C-0326-KT-7427	Material Description	HEAVY JERSEY_100% COTTON_SOLID_320_S0004 (FB-K1597)	Product Group	TOP
Article Name	NHL 26 COLOUR BLOCK RUGBY		Product Sub-Category	T-SHIRT - LS	
Created On	10-03-2025 5:13:00 PM		Season	Q3 2026	
Last Modified	12-23-2025 11:39:00 AM		Life Cycle Stage		

Part	Material	Placement	Consumption	UOM.	Comments	Supplier	Supplier Ref.	NYI NEW YORK ISLANDERS BLUE	NYR BLUE - NEW YORK RANGERS	OSB OTTAWA SENATORS BLACK	PPB BLACK - PITTSBURGH PENGUINS BLACK	RMC MONTREAL CANADIENS RED	SJS SAN JOSE SHARKS TEAL	SKN SEATTLE KRACEN NAVY
	CC LABEL - APPAREL (LT110) - Ver.#1 White Satin ground, Black text COO, Content, and Care Instructions may vary by style.		0.000 0	Each		Vendor Sourced		None	None	None	None	None	None	None
	POLY BAG - GENERIC (PK101) - Ver.#1 Clear Plastic, with suffocation warning on back, UPC sticker placement on bottom right corner of bag.		0.000 0	Each		Vendor Sourced		None	None	None	None	None	None	None
	UPC STICKER- 1" X 2.5" (TR-ST114) - Ver.#1 PLEASE PRINT WITH THERMAL PRINTER		0.000 0	Each		Vendor Sourced		None	None	None	None	None	None	None
SEE PLACEMENT FOR DETAILS	OVO x NHL Main Label & Size Tab (TR-LT285) - Ver.#1 CADICA: OVOW24_042_T		1.000 0	Each	CADICA	CADICASI A HONG KONG LIMITED		None	None	None	None	None	None	None
	OVO x NHL SIZE TAB (TR-LT289) - Ver.#1 CADICA: OVOW24_042_T		0.000 0	Each		CADICASI A HONG KONG LIMITED		None	None	None	None	None	None	None

Bill of Materials - Production | #1

Version 1

	Article Code	C-0326-KT-7427	Material Description	HEAVY JERSEY_100% COTTON_SOLID_320_S0004 (FB-K1597)	Product Group	TOP	
	Article Name	NHL 26 COLOUR BLOCK RUGBY		Product Sub-Category	T-SHIRT - LS		
	Created On	10-03-2025 5:13:00 PM		Season	Q3 2026		
	Last Modified	12-23-2025 11:39:00 AM		Life Cycle Stage			

Part	Material	Placement	Consumption	UOM.	Comments	Supplier	Supplier Ref.	NYI NEW YORK ISLANDERS BLUE	NYR BLUE - NEW YORK RANGERS	OSB OTTAWA SENATORS BLACK	PPB BLACK - PITTSBURGH PENGUINS BLACK	RMC MONTREAL CANADIENS RED	SJS SAN JOSE SHARKS TEAL	SKN SEATTLE KRAKEN NAVY
SEE PLACEMENT FOR DETAILS	NHL HOLOGRAPHIC HANGTAG (TR-HG164) - Ver.#1		1.000 0	Each				None	None	None	None	None	None	None
	OVO x NHL Hangtag (TR-HG149) - Ver.#1 CADICA OVOW24_044_ T		1.000 0	Each		CADICASI A HONG KONG LIMITED		None	None	None	None	None	None	None
	RUBBER BUTTONS (TR-BB141) - Ver.#1		0.000 0	Each	3 +1 SPARE, 24L WHITE- PLS SUBMIT FOR QLTY /SIZE APPROVAL	Vendor Sourced		None	None	None	None	None	None	None
	100% COTTON HERRINGBONE TAPE (TV116) - Ver.#1 100% Cotton Herringbone Twill Taping inside CF placket. Follow specs for width.	BACK NECK TAPE, SIDE SLITS	0.000 0	Meter	white on all colourways	Vendor Sourced		None	None	None	None	None	None	None
	EMBROIDERED EYELET (TR-DE126) - Ver.#1	underarm 2 at back and 2 at front	4.000 0	Each	dtm emb	Vendor Sourced		None	None	None	None	None	None	None
Graphics														
	TBD - SEE ARTWORK FILE (HT-102) - Ver.#1		0.000 0	Each				None	None	None	None	None	None	None

Bill of Materials - Production | #1

Version 1



Article Code	C-0326-KT-7427	Material Description	HEAVY JERSEY_100% COTTON_SOLID_320_S0004 (FB-K1597)	
Article Name	NHL 26 COLOUR BLOCK RUGBY		Product Group	TOP
Created On	10-03-2025 5:13:00 PM		Product Sub-Category	T-SHIRT - LS
Last Modified	12-23-2025 11:39:00 AM		Season	Q3 2026
			Life Cycle Stage	

Part	Material	Placement	Consumption	UOM.	Comments	Supplier	Supplier Ref.	SXB ST. LOUIS BLUES BLUE	TOB TORONTO MAPLE LEAFS - BLUE	TXB TAMPA BAY LIGHTNING BLUE	VCB VANCOUVER CANUCKS BLUE	WPN WINNIPEG JETS NAVY	WXB WASHINGTON CAPITALS BLUE
------	----------	-----------	-------------	------	----------	----------	---------------	--------------------------------	--------------------------------------	------------------------------------	----------------------------------	------------------------------	------------------------------------

Fabric

	HEAVY JERSEY_100% COTTON_SOLID_320_S0004 (FB-K1597) - Ver.#1		0.000 0	Meter				None	None	None	None	None	None
	1X1 RIB COTTON /LYCRA (FB-K1066) - Ver.#1 WEIGHT TBD	CUFF	0.000 0	Meter				None	None	None	None	None	None
	COTTON TWILL (FB-W167) - Ver.#1		0.000 0	Meter	MATCH TO REFERENCE (GOLFWANG)			None	None	None	None	None	None

Trims

	TEAR-AWAY COO TAB: OVOF21_217_T (LT138) - Ver.#1 COUNTRY OF ORIGIN TAB		0.000 0	Each		Reca Mainetti Asia Ltd	OVOF21_217_T	None	None	None	None	None	None
	5mm GROSGRAIN RIBBON LOOP (TR-TV140) - Ver.#1 FOR HANGTAG ATTACHMENT		0.000 0	Each		Vendor Sourced		None	None	None	None	None	None
	OVO 2023 Booklet Hangtag (TR-HG142) - Ver.#1 Article code: HTOVO14 1A		0.000 0	Each		Reca Mainetti Asia Ltd	HTOVO14 1A	None	None	None	None	None	None

Bill of Materials - Production | #1

Version 1



Article Code	C-0326-KT-7427	Material	Description	Product Group	TOP
Article Name	NHL 26 COLOUR BLOCK RUGBY			Product Sub-Category	T-SHIRT - LS
Created On	10-03-2025 5:13:00 PM	Material	Description	Season	Q3 2026
Last Modified	12-23-2025 11:39:00 AM			Life Cycle Stage	

Part	Material	Placement	Consumption	UOM.	Comments	Supplier	Supplier Ref.	SXB ST. LOUIS BLUES BLUE	TOB TORONTO MAPLE LEAFS - BLUE	TXB TAMPA BAY LIGHTNING BLUE	VCB VANCOUVER CANUCKS BLUE	WPN WINNIPEG JETS NAVY	WXB WASHINGTON CAPITALS BLUE	
	CC LABEL - APPAREL (LT110) - Ver.#1 White Satin ground, Black text COO, Content, and Care Instructions may vary by style.		0.000 0	Each		Vendor Sourced		None	None	None	None	None	None	
	POLY BAG - GENERIC (PK101) - Ver.#1 Clear Plastic, with suffocation warning on back, UPC sticker placement on bottom right corner of bag.		0.000 0	Each		Vendor Sourced		None	None	None	None	None	None	
	UPC STICKER- 1" X 2.5" (TR-ST114) - Ver.#1 PLEASE PRINT WITH THERMAL PRINTER		0.000 0	Each		Vendor Sourced		None	None	None	None	None	None	
SEE PLACEMENT FOR DETAILS	OVO x NHL Main Label & Size Tab (TR-LT285) - Ver.#1 CADICA: OVOW24_042_T		1.000 0	Each	CADICA	CADICASI A HONG KONG LIMITED		None	None	None	None	None	None	
	OVO x NHL SIZE TAB (TR-LT289) - Ver.#1 CADICA: OVOW24_042_T		0.000 0	Each		CADICASI A HONG KONG LIMITED		None	None	None	None	None	None	

Bill of Materials - Production | #1

Version 1











Article Code	C-0326-KT-7427	Material Description	HEAVY JERSEY_100% COTTON_SOLID_320_S0004 (FB-K1597)	Product Group	TOP
Article Name	NHL 26 COLOUR BLOCK RUGBY		Product Sub-Category	T-SHIRT - LS	
Created On	10-03-2025 5:13:00 PM		Season	Q3 2026	
Last Modified	12-23-2025 11:39:00 AM		Life Cycle Stage		

Part	Material	Placement	Consumption	UOM.	Comments	Supplier	Supplier Ref.	SXB ST. LOUIS BLUES BLUE	TOB TORONTO MAPLE LEAFS - BLUE	TXB TAMPA BAY LIGHTNING BLUE	VCB VANCOUVER CANUCKS BLUE	WPN WINNIPEG JETS NAVY	WXB WASHINGTON CAPITALS BLUE
SEE PLACEMENT FOR DETAILS	NHL HOLOGRAPHIC HANGTAG (TR-HG164) - Ver.#1		1.000 0	Each				None	None	None	None	None	None
	OVO x NHL Hangtag (TR-HG149) - Ver.#1 CADICA OVOW24_044_ T		1.000 0	Each		CADICASI A HONG KONG LIMITED		None	None	None	None	None	None
	RUBBER BUTTONS (TR-BB141) - Ver.#1		0.000 0	Each	3 +1 SPARE, 24L WHITE- PLS SUBMIT FOR QLTY /SIZE APPROVAL	Vendor Sourced		None	None	None	None	None	None
	100% COTTON HERRINGBONE TAPE (TV116) - Ver.#1 100% Cotton Herringbone Twill Taping inside CF placket. Follow specs for width.	BACK NECK TAPE, SIDE SLITS	0.000 0	Meter	white on all colourways	Vendor Sourced		None	None	None	None	None	None
	EMBOIDERED EYELET (TR-DE126) - Ver.#1	underarm 2 at back and 2 at front	4.000 0	Each	dtm emb	Vendor Sourced		None	None	None	None	None	None
Graphics													
	TBD - SEE ARTWORK FILE (HT-102) - Ver.#1		0.000 0	Each				None	None	None	None	None	None

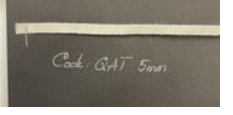
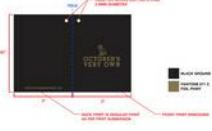
Bill of Materials - Production | #1 Material Image Sheet

Version 1

	Article Code	C-0326-KT-7427	Material Description	HEAVY JERSEY_100% COTTON_SOLID_320_S0004 (FB-K1597)	Product Group	TOP	
	Article Name	NHL 26 COLOUR BLOCK RUGBY		Product Sub-Category	T-SHIRT - LS		
	Created On	10-03-2025 5:13:00 PM		Season	Q3 2026		
	Last Modified	12-23-2025 11:39:00 AM		Life Cycle Stage			

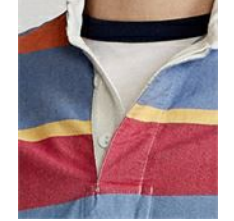
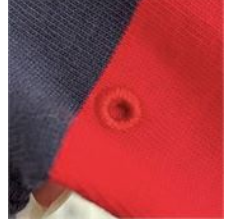
 <p>LT138 TEAR-AWAY COO TAB: OVOF21_217_T</p>	 <p>TR-TV140 5mm GROSGRAIN RIBBON LOOP</p>	 <p>TR-HG142 OVO 2023 Booklet Hangtag</p>	 <p>LT110 CC LABEL - APPAREL</p>	 <p>PK101 POLY BAG - GENERIC</p>	 <p>TR-ST114 UPC STICKER- 1" X 2.5"</p>
 <p>TR-LT285 OVO x NHL Main Label & Size Tab</p>	 <p>TR-LT289 OVO x NHL SIZE TAB</p>	 <p>TR-HG164 NHL HOLOGRAPHIC HANGTAG</p>	 <p>TR-HG149 OVO x NHL Hangtag</p>	 <p>TV116 100% COTTON HERRINGBONE TAPE</p>	 <p>TR-DE126 EMBOIDERED EYELET</p>

Construction Details - Polo

Version 1

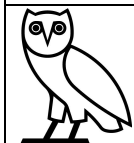

Article Code	C-0326-KT-7427
Article Name	NHL 26 COLOUR BLOCK RUGBY
Created On	10-03-2025 5:13:00 PM
Last Modified	12-23-2025 11:39:00 AM

Material Description	HEAVY JERSEY_100% COTTON_SOLID_320_S0004 (FB-K1597)
----------------------	-----------------------------------------------------

Product Group	TOP
Product Sub-Category	T-SHIRT - LS
Season	Q3 2026
Life Cycle Stage	

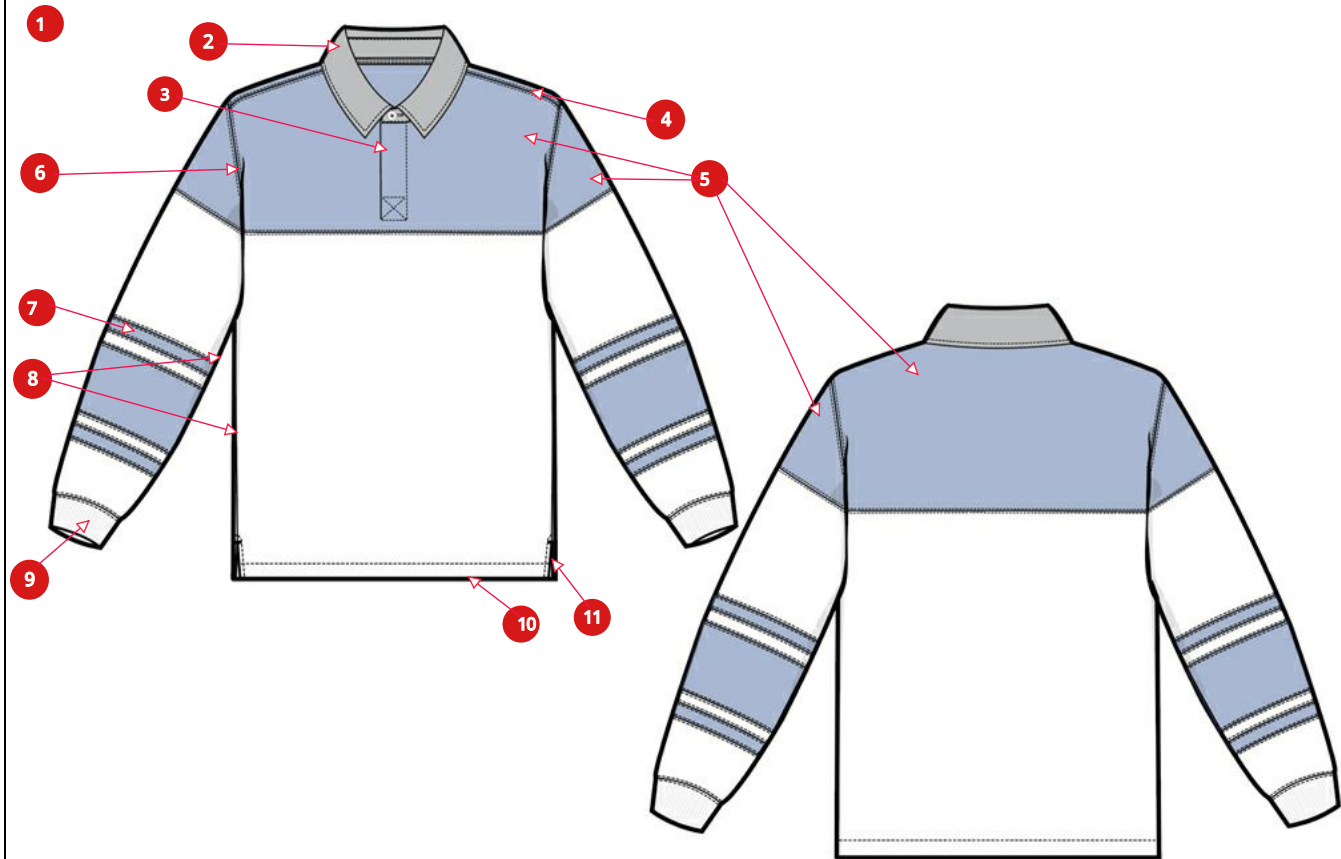

Comments

- 1 FRONT YOKE, BACK YOKE, SLEEVE PANELS ARE CONTRAST
COLLAR IS WOVEN
- 2 COLLAR AND NECK: See next page
2 ply self woven collar, with 2 ply collar stand.
- 3 CF PLACKET: See next page
Placket with hidden button closure.
- 4 SHOULDER SEAM
Set forward on body. Join with #512 mock safety stitch. 2N coverstitch straddling seam, 1/4" spacing.
- 5 YOKE PANEL/ TOP SLEEVE PANELS
Separate CUT AND SEW YOKE AND SLEEVE PANELS, all matching, join with #512 mock safety stitch. 1/4" 2N C/S straddling seam.
- 6 ARMHOLE SEAM
Sleeve join to body with #512 mock safety stitch. 2N coverstitch straddling seam, 1/4" spacing.
- 7 SLEEVE OVERLAY CONTRAST PANEL
Cut and sew contrast overlay panels, mock safety serged. 1/4" 2N C/S straddling seam.
- 8 SLEEVE INSEAM/ SIDE SEAM
Join in one operation, #512 mock safety stitch
- 9 CUFF
Rib cuff join to sleeve opening with #512 mock safety stitch. 2N coverstitch straddling seam, 1/4" spacing.
- 10 BOTTOM HEM
Edge serged. Single turn up to form hem. SN topstitch, 7/8" in.
- 11 SIDE SLIT: see next page
Slit along side seam at bottom opening. Inside cleanfinished with twill tape.

1. Phối thân trước, thân sau, tay may phối, cổ may vải woven

2. Cổ xem trang kế tiếp

3. Nẹp cổ, nút giấu xem trang kế tiếp

4. Vai chõm về thân trước. Vắt sỏ, điều rẽ 2K 1/4"

5. Phối thân trước và thân sau. Phối miếng rời, vắt sỏ, điều rẽ 2K 1/4"

6. Nách vắt sỏ, điều rẽ 2K 1/4"



7. Phối tay, phối miếng đắp lên, vắt sỏ, điều rẽ 2K 1/4"

8. Tay, sườn vắt sỏ

9. Bo tay vắt sỏ, điều 2K 1/4"

10. Lai gấp mép, điều 1K to bàn 7/8"

11. Xẻ tà 2 bên sườn, mặt trong may sạch với dây tape twill

	Article Code	C-0326-KT-7427		Product Group	TOP		
	Article Name	NHL 26 COLOUR BLOCK RUGBY			Product Sub-Category		T-SHIRT - LS
	Created On	10-03-2025 5:13:00 PM	Material Description	HEAVY JERSEY_100% COTTON_SOLID_320_S0004 (FB-K1597)	Season		Q3 2026
	Last Modified	12-23-2025 11:39:00 AM			Life Cycle Stage		

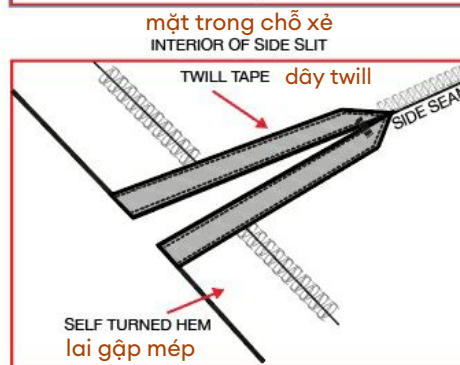
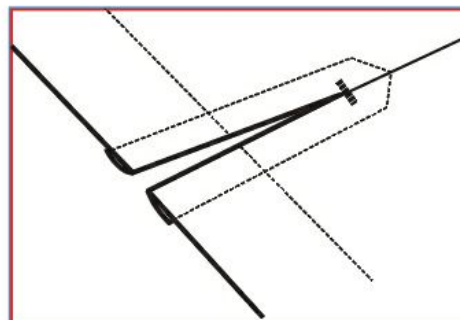
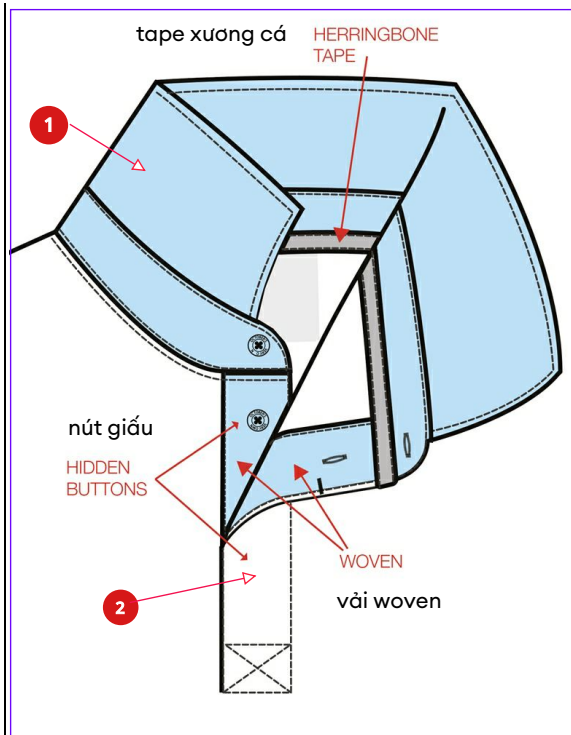

Comments

- 1 COLLAR AND NECK
2 ply self woven collar, with 2 ply collar stand. Lightly fused, cleanfinished, seams join with lockstitch. SN topstitch on collar, 1/4" in. Edge topstitch around collar stand. Single horizontal buttonhole at CF of stand, buttons stitched by machine. Collarstand join to body with #512 mock safety stitch. Inside seam allowance cleanfinished with twill tape, SN edge topstitch at top and bottom of tape, edges folded in.

1. Cổ áo

Cổ áo và chân cổ may 2 lớp. Có keo, may sạch, may ráp bằng mũi khóa. Điều mí 1K ở cổ, cách mép 1/4". Điều mí sát mép quanh chân cổ. Giữa trước chân cổ có lỗ khuy áo ngang, nút đính bằng máy. Chân cổ ráp bằng đường vắt sổ. May viền bằng dây tape vải twill, điều mí 1K trên/dưới dây tape, lưu ý gấp mép vào trong, may sạch.

2 CF PLACKET

Placket with hidden button closure. Top placket faced with woven fabric. SN edge topstitch at both sides and along bottom to close. Woven fabric recessed in 3/16" from top edge to form buttonhole facing, 2 horizontal buttonholes. Woven fabric bartacked to inside top facing (not visible from front). Under placket top & bottom layers - woven. SN edge topstitch, cleanfinished to body edge. Buttons attached, stitched by machine. Box + "X" topstitch at bottom of the placket

2. Nẹp cổ

Nẹp cổ nút giấu vào trong. Nẹp trên lót vải dệt. Điều mí 1K sát mép 2 bên nẹp và dọc theo mép dưới để đóng miệng nẹp. Vải dệt thụt vào 3/16" tính từ mép trên để làm lớp lót lỗ khuy (2 lỗ khuy ngang). Vải dệt đóng bọ vào mặt trong của nẹp trên (ko nhìn thấy từ mặt ngoài). Nẹp dưới gồm 2 lớp vải dệt. Điều mí 1K sát mép, may sạch. Đóng nút bằng máy. Điều hình vuông + chữ "X" ở cuối nẹp như hình

Measurement Sheet - LS POLO

All measurements are in Inch

Version 1





Article Code	C-0326-KT-7427
Article Name	NHL 26 COLOUR BLOCK RUGBY
Created On	10-03-2025 5:13:00 PM
Last Modified	12-23-2025 11:39:00 AM

Material Description	HEAVY JERSEY_100% COTTON_SOLID_320_S0004 (FB-K1597)
----------------------	-----------------------------------------------------

Product Group	TOP
Product Sub-	T-SHIRT - LS
Season	Q3 2026
Life Cycle Stage	



POM Code	POM Name	-Tol	+Tol	Grade	XXS	XS	S	M	L	XL	XXL	3XL
! A101	Back body length from HPS : Top	1/2	1/2	Mixed	27	27 1/2	28	28 1/2	29	30	31	32
! H101	Neck width :: SEAM TO SEAM	1/4	1/4	Mixed	6 1/4	6 1/4	6 1/2	6 3/4	7	7 1/4	7 1/2	7 3/4
H201	Front neck drop from HPS : Crew	1/8	1/8	Mixed	3 3/8	3 3/8	3 7/16	3 1/2	3 9/16	3 11/16	3 13/16	3 15/16
H301	Back neck drop from HPS Crew	1/8	1/8	Mixed	3/8	3/8	7/16	1/2	9/16	11/16	13/16	15/16
H604	Collar height at CB: not including stand	1/8	1/8	0	2	2	2	2	2	2	2	2
H607	Collar stand height at CB	1/8	1/8	0	1 1/4	1 1/4	1 1/4	1 1/4	1 1/4	1 1/4	1 1/4	1 1/4
H602	Collar point length	1/8	1/8	0	2 5/8	2 5/8	2 5/8	2 5/8	2 5/8	2 5/8	2 5/8	2 5/8
H403	Collar measurement at outer edge	1/4	1/4	Mixed	15	15 1/2	16	16 1/2	17	17 5/8	18 1/4	18 7/8
Q101	CF placket width	1/8	1/8	0	1 5/8	1 5/8	1 5/8	1 5/8	1 5/8	1 5/8	1 5/8	1 5/8
Q304	CF placket length: (neck seam to bottom edge)	1/8	1/8	Mixed	5 1/2	5 1/2	6	6	6	6 1/2	6 1/2	6 1/2
Q403	CF placket box stitch height	1/8	1/8	0	1 1/2	1 1/2	1 1/2	1 1/2	1 1/2	1 1/2	1 1/2	1 1/2
D102	Shoulder slope :: from HPS	1/8	1/8	Mixed	1 7/8	1 15/16	2	2	2	2 1/16	2 1/8	2 3/16
D103	Shoulder seam position to front	1/8	1/8	0	1/2	1/2	1/2	1/2	1/2	1/2	1/2	1/2
! D101	Shoulder width :measured on CB body	3/8	3/8	Mixed	17 1/4	18	18 3/4	19 1/2	20 1/4	21 1/4	22 1/4	23 1/4
B301	Across: Chest : at mid. armhole	1/4	1/4	Mixed	13 3/4	14 1/2	15 1/4	16	16 3/4	17 3/4	18 3/4	19 3/4
B201	Across Back : at mid. armhole	1/4	1/4	Mixed	14 3/4	15 1/2	16 1/4	17	17 3/4	18 3/4	19 3/4	20 3/4
! B101	Chest width :1" below armhole	1/2	1/2	Mixed	19	20	21	22	23	24 1/2	26	27 1/2
! C101	Bottom width: at top of slit level	1/2	1/2	Mixed	18 1/2	19 1/2	20 1/2	21 1/2	22 1/2	24	25 1/2	27
A701	Bottom hem depth	1/8	1/8	0	7/8	7/8	7/8	7/8	7/8	7/8	7/8	7/8
Q201	Side slit length	1/8	1/8	0	2 1/2	2 1/2	2 1/2	2 1/2	2 1/2	2 1/2	2 1/2	2 1/2
! E101	Armhole Straight :: measured straight	1/4	1/4	Mixed	7 7/8	8 1/4	8 5/8	9	9 3/8	9 7/8	10 3/8	10 7/8
! G101	Bicep width:1" below armhole	1/4	1/4	Mixed	7 1/4	7 1/2	7 3/4	8	8 1/4	8 9/16	8 7/8	9 3/16
! F101	L:Sleeve length overarm fr. CB neck :: 3 x point measure	1/2	1/2	Mixed	32 3/4	33 1/2	34 1/4	35	35 3/4	36 3/4	37 3/4	38 3/4
! G103	L/Sleeve width :: 1" above cuff seam	1/8	1/8	Mixed	4 7/16	4 5/8	4 13/16	5	5 3/16	5 7/16	5 11/16	5 15/16
! G104	L/Sleeve opening width: inside fold edges of cuff	1/8	1/8	Mixed	3 7/16	3 5/8	3 13/16	4	4 3/16	4 7/16	4 11/16	4 15/16
F701	Sleeve Cuff Band Height	1/8	1/8	0	2 1/2	2 1/2	2 1/2	2 1/2	2 1/2	2 1/2	2 1/2	2 1/2
B400	Front and back contrast yoke heights: HPS to panel seam	1/4	1/4	1/8	9 7/8	10	10 1/8	10 1/4	10 3/8	10 1/2	10 5/8	10 3/4
C200	CONTRAST sleeve panel, SMALLER width, seam to seam	1/4	1/4	0	1	1	1	1	1	1	1	1
N235	CONTRAST sleeve panel spacing width	1/8	1/8	0	3/4	3/4	3/4	3/4	3/4	3/4	3/4	3/4
F401	CONTRAST sleeve panel, LARGER WIDTH, seam to seam	1/8	1/8	0	5 1/2	5 1/2	5 1/2	5 1/2	5 1/2	5 1/2	5 1/2	5 1/2
N237	CONTRAST sleeve panel position up from cuff seam	1/8	1/8	Mixed	3 9/16	3 5/8	3 3/4	3 3/4	3 3/4	3 7/8	3 15/16	4

Measurement Sheet - LS POLO						All measurements are in Inch						Version 1				
	Article Code	C-0326-KT-7427				Product Group	TOP									
	Article Name	NHL 26 COLOUR BLOCK RUGBY					Product Sub-	T-SHIRT - LS								
	Created On	10-03-2025 5:13:00 PM				Material	HEAVY JERSEY_100% COTTON_SOLID_320_S0004 (FB-K1597)									
	Last Modified	12-23-2025 11:39:00 AM				Description	Life Cycle Stage									
POM Code	POM Name					-Tol	+Tol	Grade	XXS	XS	S	M	L	XL	XXL	3XL
H404	Minimum Neck Stretch					0	1/2	0	24	24	24	24	24	24	24	24

NOTES

REFERENCE: M-0222-KT-1979 + POLO RL ORIGINAL SAMPLE

ADDED EXTRA PANELS AND ADDED 1/2" MORE TO BACK YOKE WIDTH FOR STITCHING DETAILS